

West London Orbital Brent Cross West Interchange Station

Feasibility Study Report

September 2019

Project No: CS097901

Doc Ref: WLO-CAP-0100-A-RP-C-000001







Rev: P02

Client: Re / London Borough of Barnet

Issue Date: September 2019

West London Orbital – Brent Cross West Interchange Station

Feasibility Study Report

Revision P01			
	Originator	Checker	Approver
Name	James Willis	Augustus Orejobi	Chris Plant
Signature			
<u>Change Description:</u>			
Revision P02			
	Originator	Checker	Approver
Name	Augustus Orejobi	Chris Plant	Chris Plant
Signature			
<u>Change Description:</u> Amendment to review comments provided by Barnet Council on 10/09/2019.			

“This report shall be for the private and confidential use of the client for whom the report is undertaken and should not be reproduced in whole or in part or relied upon by third parties for any use whatsoever without the express written authority of the Consultant”

GENERAL DISCLAIMER:

This report has been prepared by Capita Property and Infrastructure Limited (Capita) in favour of Re / London Borough of Barnet (“the Client”) and is for the sole use and benefit of the Client in accordance with the agreement between the Client and Capita dated 10/05/19 under which Capita’s services were performed. Capita accepts no liability to any other party in respect of the contents of this report. This report is confidential and may not be disclosed by the Client or relied on by any other party without the express prior written consent of Capita.

Whilst care has been taken in the construction of this report, the conclusions and recommendations which it contains are based upon information provided by third parties (“Third Party Information”). Capita has for the purposes of this report relied upon and assumed that the Third-Party Information is accurate and complete and has not independently verified such information for the purposes of this report. Capita makes no representation, warranty or undertaking (express or implied) in the context of the Third-Party Information and no responsibility is taken or accepted by Capita for the adequacy, completeness or accuracy of the report in the context of the Third-Party Information on which it is based.

FREEDOM OF INFORMATION:

Capita understands and acknowledges the Authority’s legal obligations and responsibilities under the Freedom of Information Act 2000 (the “Act”) and fully appreciates that the Authority may be required under the terms of the Act to disclose any information which it holds. Capita maintains that the report contains commercially sensitive information that could be prejudicial to the commercial interests of the parties. On this basis Capita believes that the report should attract exemption from disclosure, at least in the first instance, under Sections 41 and/or 43 of the Act. Capita accepts that the damage which it would suffer in the event of disclosure of certain of the confidential information would, to some extent, reduce with the passage of time and therefore proposes that any disclosure (pursuant to the Act) of the confidential information contained in the report should be restricted until after the expiry of 24 months from the date of the report

Table of Contents

1	Executive summary	7
2	Definitions and Abbreviations.....	8
3	Introduction	9
4	Background	9
4.1	Brent Cross West Station	9
4.2	West London Orbital.....	9
5	Feasibility Study Remit.....	12
6	Project Area Overview	13
6.1	Project Boundaries.....	13
6.2	Key Interfacing Works/Projects	14
6.3	Existing Signalling Arrangement	14
6.4	Existing Permanent Way.....	15
6.4.1	Engineers Siding	15
6.4.2	Brent Curve Lines	15
6.5	Land Ownership and Consents	17
6.6	Existing OLE	18
6.7	Drainage.....	18
6.8	Geotechnical consideration	18
6.9	Flood Records.....	18
6.10	Ecology and other Environmental considerations.....	18
6.11	CMS/Telecoms/CCTV/Points Heating	19
6.12	Existing Services/DNO.....	19
6.13	Access point/RRAP	20
7	Feasibility Study Options Development.....	21
7.1	Key Assumptions.....	21
7.2	Platform Location.....	22
7.3	Station Platform design requirements.....	22
7.3.1	Platform height and offset.....	22
7.3.2	Usable Width of Platforms.....	23
7.3.3	Platform Type.....	23
7.3.4	Headroom on Platforms.....	23
7.3.5	Platform Radii.....	24
7.3.6	Platform Gradient	24

7.3.7	Access for All	24
7.3.8	Usable Length of Platforms.....	24
8	Other Design Considerations	26
8.1	Signalling	26
8.1.1	Up Brent Curve / Platform signalling	26
8.1.2	Down Brent Curve / Platform signalling	26
8.2	Mechanical and Electrical (M&E).....	27
8.2.1	Power requirement.....	27
8.2.2	Drainage.....	27
8.2.3	Clean Water	27
8.3	Electrification and Plant (E&P).....	27
8.4	Telecoms	27
9	Feasibility Study Options.....	28
9.1	Option 1 – One Island Platform with two platform faces.....	28
9.1.1	Track Geometry.....	29
9.1.2	Platform lengths.....	30
9.1.3	Platform Width.....	30
9.1.4	Platform Access.....	30
9.1.5	Platform drainage	30
9.1.6	Affected Assets	31
9.2	Option 2 – One Single face platform - Discarded.....	35
9.3	Option 3 – Two Single Face Platforms	36
9.3.1	Track Geometry.....	37
9.3.2	Platform lengths.....	37
9.3.3	Platform Width.....	37
9.3.4	Platform Access.....	37
9.3.5	Affected Assets	38
9.3.6	Platform drainage	40
10	Connection to BXW station.....	42
10.1	Footbridge Concept Proposal	42
10.2	Passive provision and early infrastructure investment	43
10.2.1	Interchange Connections	43
10.2.2	Land Requirements	44
10.3	Cost Estimation	44

10.3.1 Design Cost Estimation 44

10.3.2 Construction Cost Estimation 44

11 Conclusion and Recommendations..... 45

APPENDIX A – Drawings 46

APPENDIX B – Risk Assessments and Hazard Records 50

B01 - CDM HAZARD/RISK IDENTIFICATION SHEET 51

B02 – National Hazard Directory Record 54

1 Executive summary

Capita was commissioned by the Re / London Borough of Barnet Council to carry out a feasibility study for the proposed West London Orbital Station (WLO) at Brent Cross and its interface with the planned Brent Cross West Station on the Midland Main Line.

The West London Orbital is a proposed new rail service which consists of a central core between South Acton and Neasden via the 'Dudding Hill' line, with two branch options at either end, to Hendon/West Hampstead in the north, and to Hounslow/Kew Bridge in the south. The scheme has the potential to unlock further development opportunities further north beyond Hendon.

Brent Cross West is a new Station on the Midland Main Line being constructed to serve the Brent Cross Cricklewood Development which is a new town of over 7500 dwellings as well as commercial and retail space.

This report presents two options for the provision of new platforms to serve the WLO station adjacent to the Brent Cross West (BXW) station and identifies the areas where passive provision and early infrastructure investment can be made within the Brent Cross West Station development to facilitate the necessary inter-platform connections with outline cost estimates. A comparison has been made between the options presented and recommendations are provided in the concluding chapter.

2 Definitions and Abbreviations

AIP	Approval in Principle
BXW	Brent Cross West
CCTV	Closed Circuit Television
CIS	Customer Information system
DB	Down Brent Curve
DNO	Distribution Network Operator
DOO	Driver Only Operation
E&B	Earthing and Bonding
E&P	Electrification and Plant
ECI	Early Contractor Involvement
ELR	Engineers Line Reference
EMC	Electromagnetic Compatibility
EVCS	Emergency Voice Communication System
GSM-R	Global System for Mobile Communications – Railways
HVAC	Heating, ventilation, and air conditioning
LNR	Local Nature Reserve
M&E	Mechanical and Electrical
NESA	National Electronic Sectional Appendix
NHD	National Hazard Directory
OLE	Overhead Line Equipment
PTI	Platform Track Interface
PWay	Permanent Way
RRV	Road Rail Vehicle
SEU	Signalling Equivalent Unit
S&C	Switch and Crossing
SOBC	Strategic Outline Business Case
SSSI	Site of Specific Scientific Interest
TOC	Train Operating Company
TPH	Trains Per Hour
UB	Up Brent Curve
UTX	Under Track Crossing

3 Introduction

This GRIP 2 level document details the findings of the feasibility study to define the connectivity and integration requirements between the potential West London Orbital station and the planned Brent Cross West Station located on the Midland Main Line. The document is intended to support informed decision-making during GRIP Stage 3 option selection by defining the scope of investment and identifying benefits and limitations, passive provisions & design changes which could aid integration and reduce overall delivery costs.

4 Background

4.1 Brent Cross West Station

Brent Cross West is a new station on the Midland Main Line which is planned to open by 2022 to serve the Brent Cross Cricklewood development. The station is designed as a 4-platform station serving the Slow and Fast lines, arranged as two island platforms. A new bridge over the railway linking east and west sides of the line will provide access to the station concourse and also provide a pedestrian public right of way over the railway. The station will be served by up to 8 trains per hour comprising Luton and St Albans Thameslink services on the slow lines. Fast line platforms are provided for periods when the slow lines are out of use during periods of planned maintenance such as nights and bank holidays.

4.2 West London Orbital

The WLO is a proposed rail scheme which aims to enhance public transport connectivity in north-south area in west London to enable the delivery of new homes and jobs, and support mode shift to active, efficient and sustainable modes. The Strategic Outline Business Case (SOBC) for the scheme has been formally published by Transport for London (TfL) and agreement is now in place to start work on the next development phases of the scheme, focussing on technical feasibility, identification of economic benefits and funding and financing.

The West London Alliance has issued a press release announcing the decision. It includes supportive quotes from the Deputy Mayor for Transport and Alex Williams, TfL's Director of City Planning:

“The proposed West London Orbital rail line would form part of the London Overground network, connecting a number of existing lines to create a brand-new route for West and North London that would also return the four mile long Dudding Hill line between Cricklewood and Acton back to passenger use. The WLO would run from Hendon and West Hampstead to Kew Bridge and Hounslow, stopping at Brent Cross West, Neasden, Harlesden, Old Oak Common, Acton and Brentford.”

The current SOBC is in 'Phase One' of the iterative Business Case development process for this scheme (Figure 1).



Figure 1: Business Case development phases.

The scheme consists of a central core between South Acton and Neasden via the 'Dudding Hill' line, with two branch options at either end, to Hendon/West Hampstead in the north, and to Hounslow/Kew Bridge in the south (figure 2) including direct connections to the HS2 line at Old Oak Common.

This SOBC concludes that the WLO scheme has the potential to address three critical strategic issues facing west and north west London by bringing land into use for housing and employment, providing the connectivity needed to address public transport severance, and delivering benefits to the wider transport system, including existing rail lines and the road network.

In relation to its connection with the Midland Main Line it is proposed that at the northern end of the route the WLO service will split, with a northern connection to Hendon joining the Midland Main Lines at Brent Curve Junction, which is adjacent to the Brent Cross West Station and a southern connection to West Hampstead joining the Mainland Main Lines at Cricklewood Curve Junction.

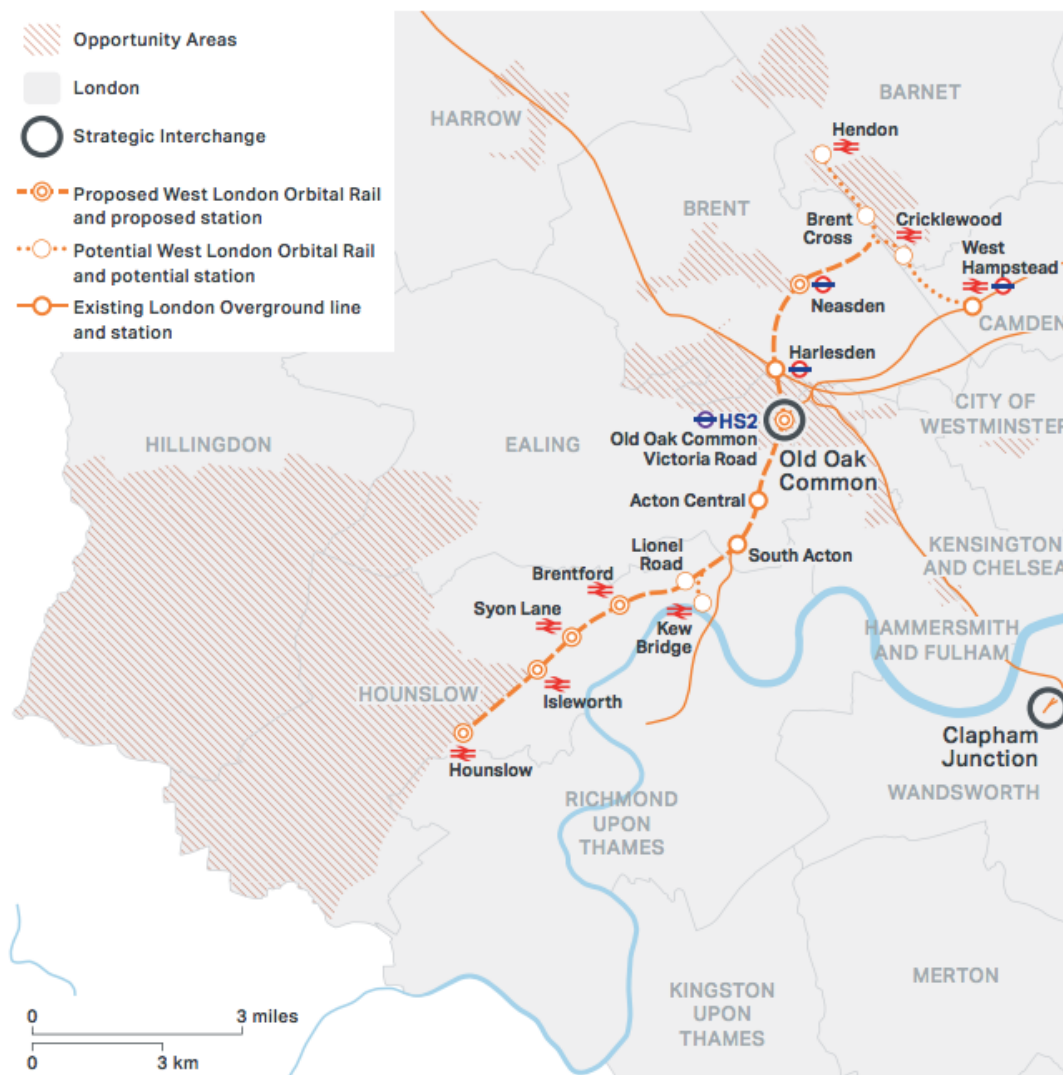

Figure 2: WLO proposal (as described in Mayor’s Transport Strategy).

The outlines key indicative project milestones are presented in Table 1 below.

Table 1: project milestones excerpt from clause 0.6.1.4 of WLO SOBC.

Project milestones	Milestone Description	Date
	Further feasibility	2019-2021
	Planning, Design, Approval and Procurement	2021-2022
	Construction	Early 2020s
	Operation	❖ 2026 for Phase 1 ❖ 2029 for Phase 2

5 Feasibility Study Remit

1. Undertake an outline feasibility study with 2 / 3 options for the integration of the WLO railway with the BXW station. This shall include the following considerations:
 - Potential locations of the WLO platforms,
 - Interchange options between the new WLO platforms and the proposed BXW station,
 - Identification of any rail infrastructure requiring to be relocated to enable the WLO platforms to be introduced,
 - Identify potential impact of options on operational rail boundary,
 - Extent to which options should cater for different future train lengths (e.g. 4 car / 8 car)
 - Consideration of potential cost implications for each option, to avoid proposing unrealistic options,
 - Identification of high-level risks and assumptions associated with each option.
2. Identify where passive provision or early infrastructure investment (i.e. as part of BXW station) may be advantageous in reducing future costs or programme timescales.
3. Provide a cost estimate of required design changes to the BXW station, recognising the current GRIP 4 approved design.
4. Provide a high-level cost estimate of any identified passive provision or advanced infrastructure items including relocation of rail infrastructure.

6 Project Area Overview

The site of the potential West London Orbital interchange station is in the Brent Cross area of the London Borough of Barnet, England. The WLO platforms will be located adjacent to the new Brent Cross West Station on the Dudding Hill line which links London Borough of Barnet and the Thameslink corridor to west London. The WLO platforms will be served by the Up and Down Brent Curve Lines. The area available for the development (figure 3) lies between the existing Down Hendon / Down Reception Siding and the railway boundary fence line adjacent to Flip Out Trampoline car park.

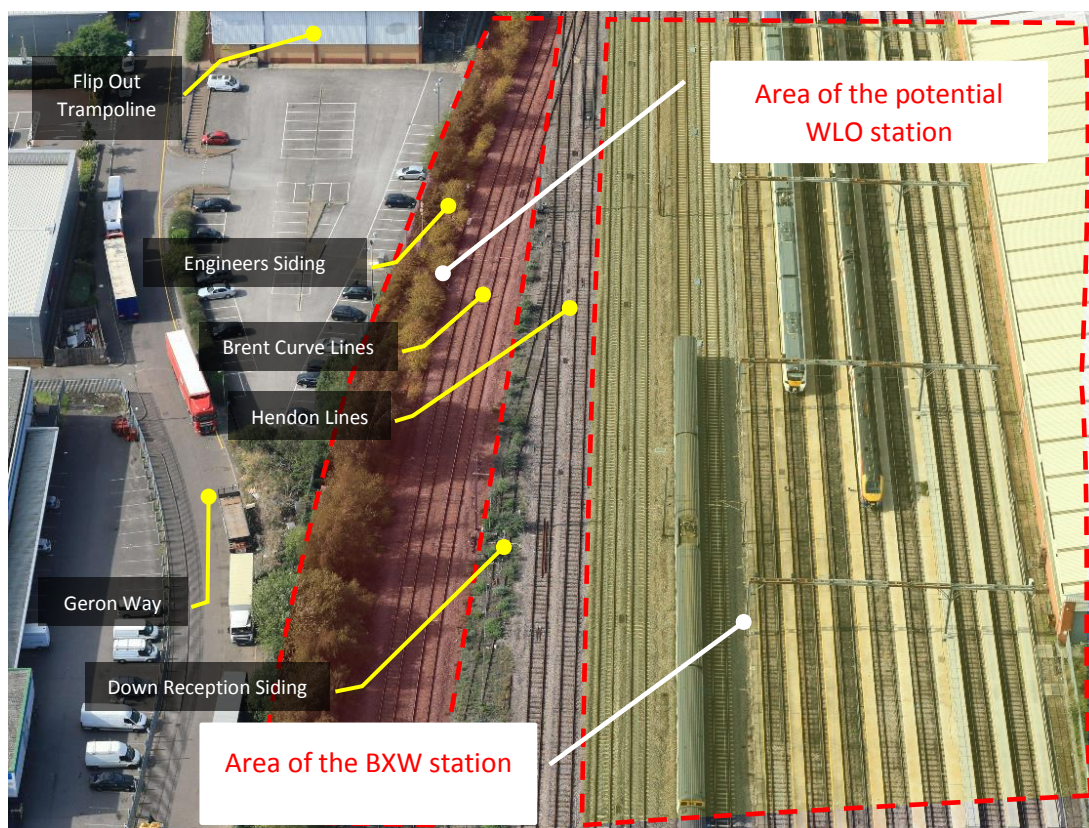

Figure 3: Aerial image of the proposed site showing existing track layout prior to the BXW station development.
Source: Routeview 12/09/16.

6.1 Project Boundaries

Operating Route:	LN3222 - Brent Curve Jn to Dudding Hill Junction
ELR and Mileage:	Brent Curve Junction (SPC1 6m 04ch / BDH 0m 00ch) to Geron Way Authorised Access Point (BDH 5m 16ch)
OS Ref:	Latitude: 51.568564, Longitude: -0.22675127
Nearest Address	Flip Out, Geron Way, London Borough of Brent, London, Greater London, England, NW2 6LW, United Kingdom

6.4 Existing Permanent Way

6.4.1 Engineers Siding

The Engineers Siding located to the west of the Brent Curve is currently redundant evident by overgrown vegetation, the installation of a GSM-R signpost in the 4 foot, and a ballast mound over the line. The area has been de-vegetated as at the time of site walkout on 29/05/2019.

The exit from the siding to the Hendon lines is controlled by exit signals WH447 located in the Engineers Signing cess at ELR: BDH 0m 84yds approximately.

Movements from the Hendon lines into the siding are controlled by entry signals WH466 and WH468 mounted on the signal gantry which is located 300m north of Brent Curve junction at ELR: SPC1 6m 369yds approximately, and a ground position light signal WH586 located in the Up Hendon and Down Fast '6 foot' at ELR: SPC1 6m 289yds. The signal currently appears to be out of service with its main signal aspects blocked out. There is also an OLE mast which appears to be installed directly before the signal post on the exit approach to the Down Hendon line (figure 5).



5 (a)



5 (b)



5 (c)

Figure 5: existing signal WH477; assumed to be currently non-operational.

6.4.2 Brent Curve Lines

The Brent Curve is made up of the Up Brent Curve and the Down Brent Curve aligned side by side between the Engineers Siding and the Down Hendon/Down Reception Siding. The Brent Curve is currently a 4-mile-long freight route between Brent Curve Junction (ELR: SPC1 6m 88yds /BDH 0m 0yds) and Dudding Hill Junction (BDH 6m 110yds). Its condition is not known as at the time of this feasibility study. A track condition survey will need to be completed at the next development stage to identify the scope of track works required.

Up Brent Curve: The line is adjacent to the Engineers Siding and travels from Acton towards the Hendon, Bedford & Leicester. It joins the Hendon lines at Brent Curve Junction (ELR: SPC1 6m 88yds) via track point 824 (figure 4). Exit from the Up Brent Curve to the Down Hendon is controlled by signal WH453 which is located in the 10 foot (i.e. space between the redundant Engineers Siding and the Up Brent Curve) at ELR: BDH 0m 263yds approximately.

Down Brent Curve: The line is adjacent to the Down Hendon / Down Reception Siding and travels from Brent Curve Junction towards the Acton. Exit from the Up Hendon at Brent Curve Junction (ELR: SPC1 6m 88yds) is via track point 823 (figure 4). The line is controlled by signal WH468 which is mounted on the signal gantry which is located 300m north of Brent Curve junction at ELR: SPC1 6m 369yds approximately.

The Hendon lines are to remain unchanged except where alterations are required to the existing Brent Curve lines turnout arrangements from/to the Hendon lines. No infringement or alteration is to be made to the Down Reception Siding line which provides access to the new Deutsche Bahn Cargo Freight Facility. The existing relationships between the Brent Curve lines and the adjacent lines are depicted in the National Electronic Sectional Appendix (NESA) extracts in figures 6a and 6b.

LOR	Seq.	Line of Route Description	ELR	Route	Last Updated	
LN3222	001	Brent Curve Jn to Dudding Hill Jn	BDH	London North Eastern	02/02/2013	
Location	Mileage M Ch	Running lines & speed restrictions	Signalling & Remarks			
Brent Curve Jn	6 04 0 00		<table border="1"> <tr> <td>TCB RA8</td> <td>West Hampstead SB</td> <td>GSM-R</td> </tr> </table>	TCB RA8	West Hampstead SB	GSM-R
TCB RA8	West Hampstead SB	GSM-R				
Route Boundary	0 08 * 0 54		AWS not provided on goods lines			
Continued In Network Rail Anglia Route Sectional Appendix						
Dudding Hill Jn	1 03					

Figure 6a: National Electronic Sectional Appendix extract showing the Brent Curve lines relative to route boundaries.

LOR	Seq.	Line of Route Description	ELR	Route	Last Updated
LN3201	007	St. Pancras to Tapton Jn (via Derby)	SPC1	London North Eastern	09/10/2017
Location	Mileage M	Ch	Running lines & speed restrictions		Signalling & Remarks
Cricklewood Depot Jn Cricklewood SB	5 40 *				<p>TCB West Hampstead SB RA8 AC; York ECR</p> <p>GSM-R</p> <p>CW - Up Hendon at 5m 40ch</p> <p>UH = Up Hendon (PF throughout) Not Electrified. DH = Down Hendon (PF from WH31 signal 3m 38ch to WH449 signal 5m 68ch) Not Electrified.</p> <p>DR = Down Reception Siding. UG1 = Up Goods No1 (PF) UG2 = Up Goods No2 (PF) NN = North Neck AWS not provided on goods lines CA = Cricklewood Aggregate Terminal (C.A.T.)</p> <p>Cricklewood Depot: TW = Cricklewood Depot Train Washer WR = Cricklewood Depot Washer Road UD = Cricklewood Depot Up Departure Road SS = To / From Cricklewood Depot South Sidings Nos 1 - 5 (length = 500 Metres) FR = Cricklewood Depot Fuel Road NR = Cricklewood Depot North Reception Road Cricklewood Depot North Siding No 1 length = 333 M Cricklewood Depot North Sidings Nos 2 - 6 length = 434 Metres.</p> <p>CW - Up Hendon at 6m 00ch DB = Down Brent Curve UB = Up Brent Curve ES = Engineers Siding</p> <p>To / from Dudding Hill Jn, see LN3222 seq 001</p> <p>CW - Down Hendon at 6m 15ch</p> <p>\$ = Down Direction from Brent Curve Jn. available for Shunt Moves only.</p>
	5 42 *				
	5 58 *				
	5 63				
Brent Curve Jn	5 73 *				
	6 04				
	6 10 *				
	6 17 *				

Figure 6b: National Electronic Sectional Appendix extract showing the Brent Curve lines relative to the adjacent lines.

The existing line speed on the Brent Curve lines is 30-mph with a 10-mph limit around the turnout from/to the Hendon lines.

6.5 Land Ownership and Consents

The potential WLO station location is within Network Rail property. As part of the Brent Cross West project some existing Network Rail land will transfer to the Council for the construction of the new Waste Transfer Station. The areas highlighted in blue in figure 7 are currently identified as 3rd party land. See also drawing reference WLO-CAP-01000-A-DR-C-000001 Rev. P01 in Appendix A. The Flip Out Trampoline car park to the west of the railway is also being acquired by the council from 3rd party ownership under the Brent Cross West station project.

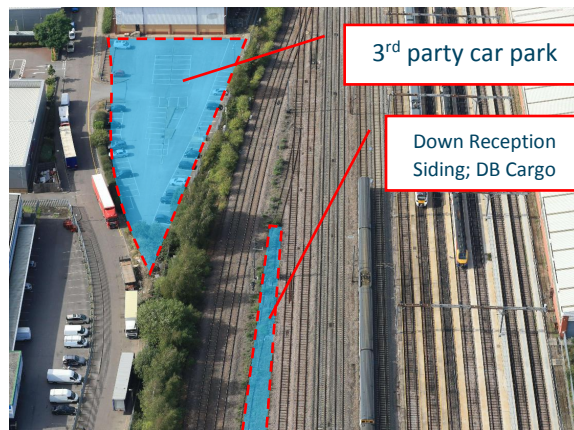

Figure 7: Areas of 3 party land; not to scale.

6.6 Existing OLE

Currently, the Slow and Fast lines (4 in total) are all electrified by overhead line equipment (OLE). The Hendon lines are not electrified however the OLE that covers the Hendon and Fast lines are wire gantries with a return conductor/earth wire running between stanchions. The OLE for the Slow lines are single track cantilevers with the Down Slows utilising the same stanchion as that for the Up fast. The sidings and both Brent Curve lines are not electrified.

6.7 Drainage

Longitudinal track drainage runs between the tracks down the '6ft' of the Slow, Fast and Hendon lines. The drainage chambers for the Up and Down Slow lines have blue GRP grated lids which indicates it has been recently renewed whereas the other lines have rusted metal grated lids. There does not appear to be any track drainage for any of the sidings or Up and Down Brent Curves. Further inspections should be carried out to determine the exact location and condition of existing drainage runs.

6.8 Geotechnical consideration

For this study it is assumed that the ground investigation model for the BXW station will be applicable to the potential WLO station and therefore pile foundations will be required for structural support e.g. for footbridge, lift shaft, and other platform buildings. See Brent Cross Station Development Area Ground Investigation Report 'CBXT-CAP-0600-XX-RP-C-0168 rev P02'.

Table 2: Strata anticipated to be present across the site (excerpt from Brent Cross Station Development Area Ground Investigation Report ref: CBXT-CAP-0600-XX-RP-C-0168 rev P02).

	Geological Unit	Typical Description
Superficial depth 0.7 to 7.1m	Made Ground	Variable, predominantly granular materials.
	Estuarine Alluvium	Soft grey silty organic clay (possibly containing peat).
Solid Geology	London Clay Formation: 28.4m Max Thickness (full thickness not proven)	Firm to hard, blue-grey or grey-brown, slightly calcareous, silty to very silty clay with sand pockets, shell fragments and selenite crystals.
	Lambeth Group:	Vertically and laterally variable sequences mainly of clay, some silty or sandy, with some sands and gravels, minor limestones and lignites and occasional sandstone and conglomerate.
	Not encountered	

6.9 Flood Records

A desktop study report obtained from the Environment Agency long term flood risk information which indicates that the site is not at risk from flooding from rivers. However, some areas of the site are at risk of surface water flooding.

6.10 Ecology and other Environmental considerations

The preliminary Brent Cross Station Ecology Report 'ENV01' which was completed by Capita in October 2015 has relevance to this feasibility study. The desk study results from Greenspace

Information for Greater London (GiGL) identified one site with national statutory designation and one Local Nature Reserves (LNR) within the search area:

Brent Reservoir (Welsh Harp) is a 68.6ha Site of Special Scientific Interest (SSSI) and is located approximately 0.3km north-west of the site. The Brent Reservoir is designated for its breeding water birds and in particular for significant numbers of great crested grebes. The diversity of wintering waterfowl and the variety of plant species growing along the water margin are also of special note for Greater London.

Brent Reservoir (LNR) is 97.11ha and is located approximately 0.3km north-west of the site and incorporates the SSSI. The site consists of open water, marshes, trees and grassland and is surrounded by meadows, woodland and parks. The reservoir is associated with diverse bird species including great crested grebe.

Neither of these designation areas has an impact on the proposed works.

Invasive species: Japanese knotweed (*Fallopia japonica*) has been previously identified in the area of the proposed WLO station as well as Giant Hogweed on adjacent land.

Fly Tipping: This is currently an issue in the area of the proposed works. This issue is not expected to persist following the development works in the area. However, option 1 (island platform) may be more susceptible to fly tipping between the boundary and the station platform due to the vacancy of the area being similar to the existing arrangement.

6.11 CMS/Telecoms/CCTV/Points Heating

Multiple trough routes, both concrete and polymer are present in the cess along the Geron Way boundary fence and there appears to be sections of troughing in the 10ft between tracks. Sections of the troughs appeared to have been renewed recently however, the majority is missing trough lids and have been damaged. Frequent orange pipe/hollow sleeper crossings have been installed instead of UTX's.

There is a CCTV mast located within the NR boundary adjacent to the Flip Out car park. This has 3 cameras that covers the rail corridor and the carpark. There are two lighting columns located in the Flip Out car park directly adjacent to the palisade boundary fence that provide lighting to the car park.

6.12 Existing Services/DNO

The Network Rail National Hazard directory record (appendix B02) has been reviewed for the area of the proposed WLO station. The record identified the presence of the following hazards in close proximity to the proposed site:

- Invasive plant – Japanese Knotweed
- Buried electric cables – 11 and 400kV
- Electrification – HV 25kV
- Buried Foul water services – 39 Diameter Sewer.

These are hazards to be considered during design development and site activities planning. The exact position and alignments of these services are unknown and will require further investigation at the next development stage.

There does not appear to be any railway undertrack crossings (UTX).

There is a Distribution Network Operator (DNO) cubicle located in the Flip Out car park for the points heating switch supply. The cabinet is in a fair condition. There is a points heating control cubicle located in the cess near the proposed BXW overbridge.

6.13 Access point/RRAP

Geron Way Authorised Vehicle Access Point: is a vehicle access point which is located south of the potential WLO station on Geron Way which is to be relocated closer to the BXW station as part of the new Waste Transfer Station installation. At the current location of the access point there is a barrow crossing/substandard RRAP that covers the Brent Curves and the adjacent siding.

As at the time of the site visit on 29/05/2019 there are multiple skips in close proximity to the vehicle access point which appeared to be used for de-vegetation works. There is a portable cabin that is believed to be used as welfare facilities. There is a generator cabinet located on the public side of the boundary at the access point that is in fair condition.

PC World Authorised Vehicle Access Point: is a vehicle access point located north of the potential WLO station accessed from the Currys PC World car park adjacent to the Down Goods line at ELR: SPC1 6m 440yds.

7 Feasibility Study Options Development

7.1 Key Assumptions

The following are the key assumptions on which the WLO station platform arrangement have been developed:

Table 3: WLO Station Feasibility Study key assumptions.

Asset	Assumptions	Comments
Platform Type	Platforms are to be 'through platforms' and not 'terminal platforms'.	Terminal platforms have not been considered in the feasibility study. It is unlikely that this type of platform could be installed at this location due to the existing track gradient not being suitable unless a significant track remodelling investment is commissioned.
Electrification	Lines will not be electrified.	An electrification project can be developed at a later stage. This will need to consider the system network beyond the potential WLO station.
Line speed	Existing turnout speeds of 10mph near the Brent Curve junction will not change.	The virtual transition between the Brent Curves and a straight geometry didn't achieve an acceptable Rate of Change of Cant for 30mph.
Redundant tracks	There is no aspiration to reactivate the disused Engineers Sidings.	The Engineering sidings will need to be removed to create space for the potential WLO platforms.
Down Reception Siding	The down reception siding connection to the Hendon Lines is fixed in location.	The reception siding limits the shunt length for trains in the freight facility.
Rolling Stock	Train lengths are based on multiples of 20.5m stock.	The platform length has been developed based on 4 and 8 car multiples of 20.5m car length which are typical for urban routes. If stock with longer car lengths are used, platforms will need to be resized accordingly.
Turnback Facility	A turnback facility will be provided at Hendon or beyond.	The turnback facility is required to allow the southbound WLO trains from Hendon. This issue is not considered within the scope of this report but may have an impact on the operational requirement at BXW WLO station.

7.2 Platform Location

A key requirement from this feasibility study is to provide an interchange connection between the potential WLO and BXW stations. Based on proximity and envisaged traverse between the two stations the practical location for the WLO station is the area to the west of the BXW station.

This area provides an ideal position for the connection to the BXW station.

The position of the existing Brent Curve junction is a key constraint to the position of the WLO platforms as the platforms must be located north or south of this point. Locations to the north on the Hendon lines are limited by lack of available land between the Hendon lines and the existing retail park. The location to the south of the junction on the Brent Curve is however both adjacent to the BXW platforms and has land available to accommodate the necessary platforms. Therefore, no other areas have been considered in the study.

The current Brent Curve line speed is 30-mph. The turnout speed from/to the Hendon lines is 10-mph. It has been assumed that this line speed will not change due to existing site constraints such as the positions of adjacent lines and the railway boundary. It is believed that 10-mph turnout will be adequate for trains calling at the station. This location allows minimum track radii of 1000 m to be installed in all scenarios considered in the options presented in this report.

7.3 Station Platform design requirements

A station capacity assessment will need to be carried out at the next development stage to determine the optimum usage and flow of passengers through the proposed WLO station. The capacity assessment should be based on commuter demand from the peak periods with considerations for normal and abnormal operations. The station platforms arrangements and access/egress options presented in this report are based on the main requirements for new stations as set out in the European Technical Standards for Interoperability (TSI) for Infrastructure and Rail Group Standard 7016 'Interface between Station Platforms, Track and Trains' and the accompanying guidance.

7.3.1 Platform height and offset.

A UK standard platform height of 915 mm is assumed for the purpose of this report. This will need to be confirmed for all stations on the route as a whole, depending on the planned rolling stock for the services as well as fit with existing rolling stock cleared for the route. Platforms are to be offset at 730 mm from running rail edge (within a tolerance of +15 mm, -0 mm) in accordance with the lower sector infrastructure gauge set out in "GIRT7073 - Requirements for the Position of Infrastructure and for Defining and Maintaining Clearances". The offset is measured parallel to the plane of the running edge of track to provide for boarding and alighting of trains, assuming that the trains are built to the requirements of "GMRT2173 - Requirements for the Size of Vehicles and Position of Equipment". It also provides for the passage of trains at line speed, including freight trains, in accordance with the requirements for gauge clearance.

7.3.2 Usable Width of Platforms

The minimum usable width of a new single face platform shall not be less than 2500 mm given the maximum line speed on the Brent Curve lines will be <100 mph.

The minimum usable width of a new double face platform shall not be less than 4000 mm given the maximum line speed on the Brent Curve lines will be <100 mph.

These are minima and platform widths need to also take account of platform infrastructure and provision of a semi-enclosed waiting area.

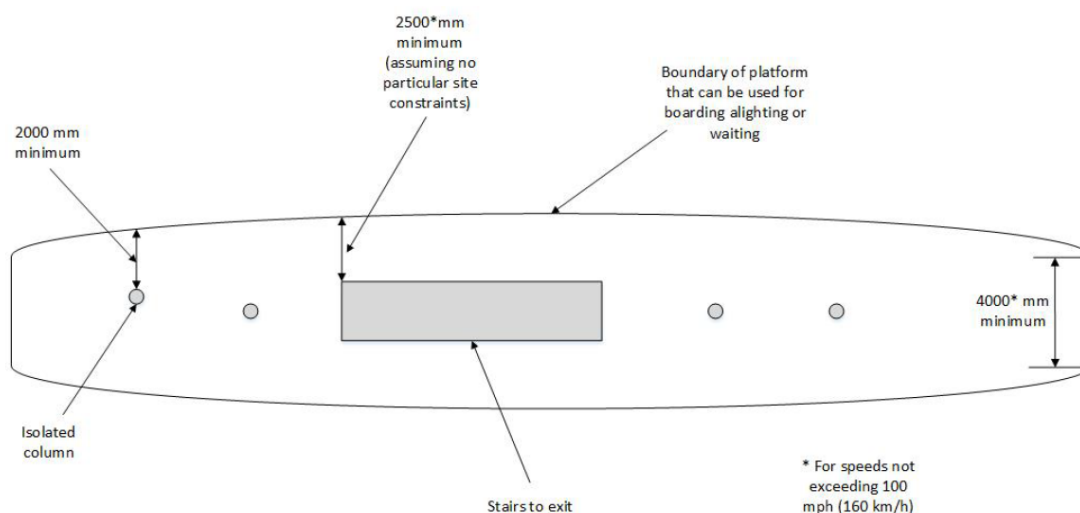

Figure 8: excerpt from RIS-7016-INS showing example of the determination of the minimum usable platform width for a double face platform (not to scale).

7.3.3 Platform Type

The study looked at providing through platform rather than terminal platforms based on the aspiration to continue the service to Hendon as depicted in the WLO proposal model in figure 2.

7.3.4 Headroom on Platforms

Platform canopy headroom will need to be considered and developed at the next stage in accordance with “GIRT7073 - Requirements for the Position of Infrastructure and for Defining and Maintaining Clearances” see figure 7.

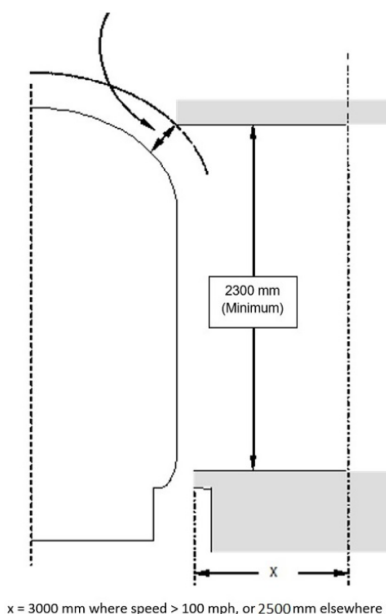

Figure 9: excerpt from RIS-7016-INS showing requirements for headroom at station platforms.

7.3.5 Platform Radii

To meet stepping distances the minimum track radii adjacent to the platform will be 1000m.

7.3.6 Platform Gradient

There is no explicit requirement following the latest revision to RGS 7016 to achieve 1:500 however there are limits of normal acceptability c1:200 and a risk assessment is often needed. The Track Design Handbook still refers to 1:500 to be achieved where possible. BXW station platform gradient is 1:200. The existing track gradient through the proposed WLO station is also circa 1:200. It is therefore, likely that similar gradient will be acceptable for the WLO station subject to risk assessment including consideration of proximity to junction.

7.3.7 Access for All

The station will be designed to meet the European Technical Standards for Interoperability (TSI) for Persons of Reduced Mobility and the Department for Transport (DfT) Design Standards for Accessible Stations. The latter is the UK code of practice for accessible station design.

A new footbridge will be required to create the required interchange between the WLO and BXW stations. As this stage it is assumed that the clearance from track level to the BXW footbridge can be replicated for the WLO interchange footbridge. This provides for a minimum of 6.2m clearance over the running lines which meets electrification requirements.

7.3.8 Usable Length of Platforms

One of the remits of this feasibility study is to confirm the extent to which the options presented are able to cater for different future train lengths (e.g. 4 car / 8 car). It is uncertain at this stage which rolling stock will be used on the route therefore, the study has based the train lengths on a maximum car length of 20.5m which is typical for passenger trains.

The platform lengths presented in this study report allows for inaccurate stopping of 4000 mm before the end of an operational platform. A further 1000 mm is allowed behind the end of the platform to create a lineside access landing area. No allowance has been made for train coupling and de-coupling because it is not deemed to be operationally required at this location. The minimum platform length calculation is presented in table 4.

However, additional platform length will be provided where:

- compliant platform edge clearances to the platform structure cannot be achieved within the minimum total lengths (see figure 6).
- allowance for future maintenance and tactile inspection; this will typically be a minimum of 3000 mm beyond a structural face e.g. list shafts.

Table 4: minimum platform length calculation

		8-car	4-car
A	Train length (m)	164	82
B	Stopping distance (m)	4	4
C	End of platform landing (m)	2	2
	Min. Operational length (A + B) (m)	168	86
	Min. Total length (A +B+ C) (m)	170	88

8 Other Design Considerations

The platform arrangements presented in the options identified in this feasibility study have been sized to meet minimum requirements as discussed under section 7. There are other station operational assets and furniture that will need to be considered during the next stage development works. This study assumes that all options provide lighting, CCTV, Customer information systems, seating and semi enclosed waiting facilities and toilets. Revenue earning kiosk is optional but can be considered. The high-level interdisciplinary interfaces are discussed below.

8.1 Signalling

Signalling will be required for the station for both options considered at the next development stage (i.e. Option Selection) to confirm the requirements for all scenarios of authorised and unauthorised train movements from and to the platforms and Brent Curve lines. The design will need to be in collaboration with Network Rail, the Freight Operating Companies (FOC) and Train Operating Companies (TOC). See also section 6.2.

8.1.1 Up Brent Curve / Platform signalling

There is an inherent risk with the train movement from the Up Brent Curve to the Hendon lines. It is envisaged that a new signal will be required on the Up Brent Curve to dispatch trains from the WLO Up platform. This signal will need to be positioned to allow adequate driver sighting and stopping in the event of a Signal Passed at Danger (SPAD). The design will need to consider.

With respect to clearance to the Brent Curve Junction Options 1 and 3 allow a c.113m and c.104m clearance from the end of physical platform to the convergence point of the Up Brent Curve and the Down Hendon respectively. The platform length will need to be shortened and shorter train lengths considered should the signalling design requires a greater clearance from the convergence point to allow a signal to be placed with sufficient stand back distance. This is due to the land boundary constraint depicted on drawing WLO-CAP-0100-A-DR-C-00002 (Appendix A).

8.1.2 Down Brent Curve / Platform signalling

It is not envisaged that significant alterations will be required for train movements from the Hendon lines to the Down Brent Curve/platform because this is currently an authorised movement. However, they may be alterations to train detection system due to other signalling works on the Brent Curve lines and the proposed alterations to the current turnout arrangements between the Brent Curve and the Hendon lines.

With respect to clearance to the Brent Curve Junction Options 1 and 3 allow a c.34m and c.70m clearance from the end of physical platform to the convergence point of the Down Brent Curve and the Down Hendon respectively. The platform length will need to be shortened and shorter train lengths considered should the signalling design requires a greater clearance from the convergence point to allow a signal to be placed with sufficient stand back distance. This is due to the land boundary constraint depicted on drawing WLO-CAP-0100-A-DR-C-00002 (Appendix A).

8.2 Mechanical and Electrical (M&E)

Mechanical and Plant design requirements for the WLO station will need to be considered for both options in more detail at the next development stage (i.e. Option Selection). The following are the areas of further development that will be required:

8.2.1 Power requirement

As at the time of this feasibility study it was not clear if the WLO and BXW stations will share a single power supply, but it is assumed for pricing ease that a separate DNO application will need to be made for the WLO station in the future. The required capacity will need to consider station operational and revenue assets such as waiting rooms, toilets, kiosks, lighting, CIS, emergency equipment, etc.

8.2.2 Drainage

Subsurface management of the surface water and waste from toilets and kiosks will require the input of the M&E discipline. It is envisaged that a discharge flow rate similar to the one stipulated for the BXW station discharge consent will apply and therefore drainage attenuation will be required. Further site investigation should be carried out to confirm the possible location for WLO discharge outfall. This is likely to be via an existing drainage route to the west of the proposed station.

8.2.3 Clean Water

The supply of clean water is to be considered at the next development stage. A new application is envisaged for WLO station.

8.3 Electrification and Plant (E&P)

See section 6.2.

8.4 Telecoms

The integration of the telecoms design with the WLO route network will need to be considered at the next development stage. Two key areas of design requirement envisaged are telecoms for station operation and telecoms associated with the management of train movements.

The further works identified in this section is by no means comprehensive. Other project requirements are likely to be elicited during the liaison with the stakeholders.

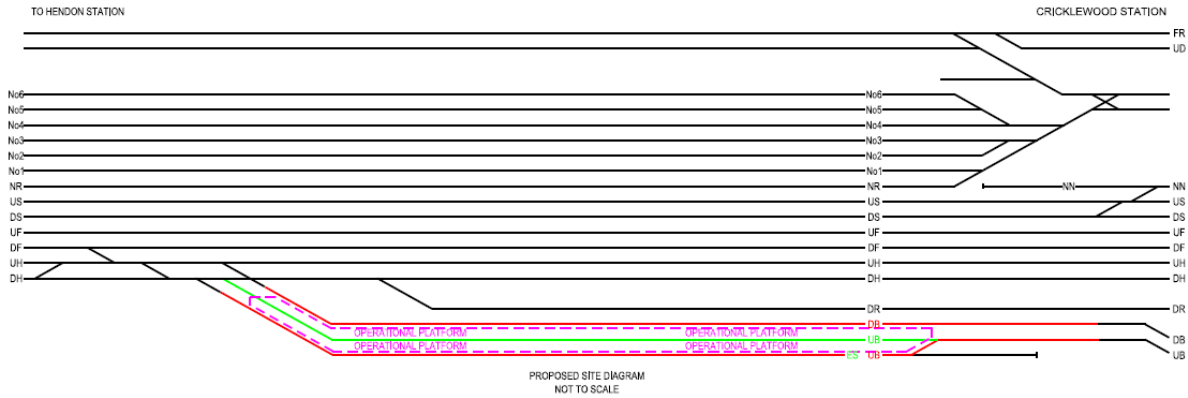

Figure 10b: Option 1 PWay line diagram.

9.1.1 Track Geometry

Where a curve with radius tighter than 870 m had to be implemented, the virtual transition between these curves and a straight geometry didn’t achieve an acceptable ‘Rate of Change of Cant’ for 30-mph, so the speed limit is to be 10-mph within those areas. These areas are near the turnouts; but a line speed of 30-mph through the platform provides normal track parameters (figure 10c).

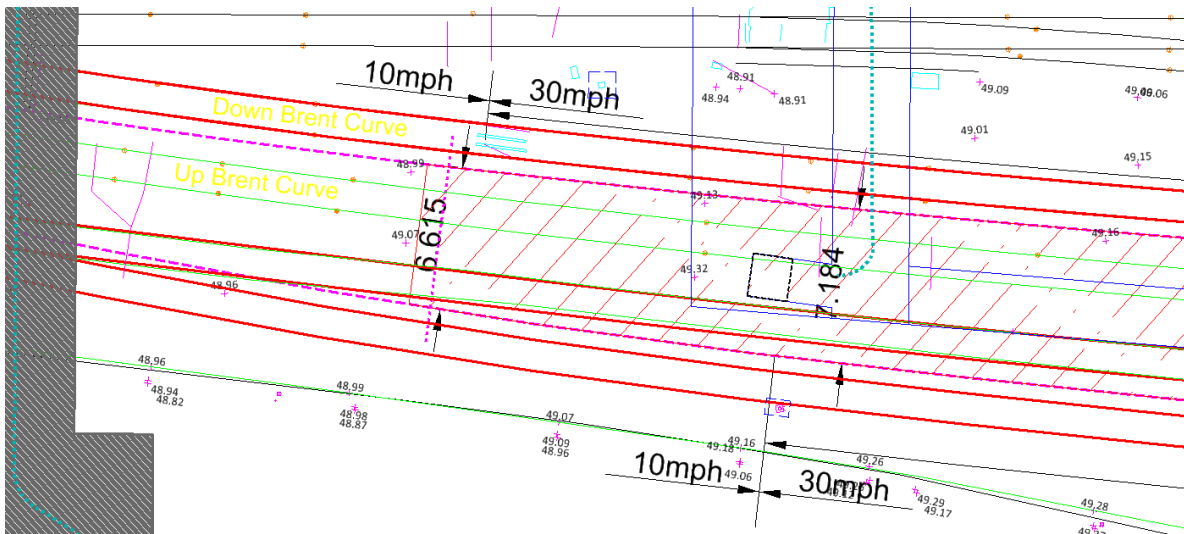

Figure 10c: track line speed limits near turnout to/from Hendon lines.

The existing track gradient through the proposed WLO station is approximately 1:340 measured between existing Down Brent Curve crossover rail level of 48.87 m and the rail level at the proposed tie-in point which is adjacent to the Geron Way access point. A 1:500 gradient will therefore require track lowering by about 320mm on the Brent Curve lines towards the Geron Way access point area. Alternatively, the current track gradient could be maintained subject to appropriate risk assessment. See section ‘D.7.1: Trap Point and Vehicle Retardation’ of the NR/L2/TRK/2049 – Track Design Handbook.

9.1.2 Platform lengths

This option achieves the minimum required platform length of 170 m for an 8-car and 4-car trainset. The proposed total platform lengths are 180 m for the 8-car length and 92 m for the 4-car length. See details on drawing reference WLO-CAP-01000-A-DR-C-000002 Rev. P01 in Appendix A.

9.1.3 Platform Width

The result of the track alterations would create space to provide a platform with varying width with the maximum and minimum widths of 8420 mm and 6535 mm respectively. The arrangement allows for minimum of 2500 mm clearance from platform buildings to platform edge based on 2.0 m x 2.0 m lift shaft and a maximum 2.7 m wide staircase.

9.1.4 Platform Access

Access to the station platforms will be through the Brent Cross West main concourse which will have revenue protection ticket barriers as per the BXW station AIP design. A new footbridge connected to the main concourse of the Brent Cross West Station will provide the interchangeability between the two stations. Access to the platforms will be by lift and stairs.

Mobility Impaired passengers can access the new platforms via the Brent Cross West footbridge and lifts up to the new WLO station footbridge which will have a lift to platform level.

If warranted it would be possible to extend the bridge to provide a second access directly from Geron Way however, land take will be required.

9.1.5 Platform drainage

It is assumed that platform drainage will require a separate network with new outfall and consent to discharge to the West of WLO Platforms.



9.1.6 Affected Assets

Table 5 below describes the impact of option 1 on the existing lineside assets. This applies to both the 8 car and 4 car trainsets.

Table 5: list of assets affected by Option 1 proposal.

Asset Impact		Description
<p>Proximity to new UB alignment</p>		<p>Main cable route troughs will require protection or lift and slew in areas where risk of damage may occur due to proximity of new Up Brent Curve alignment.</p>
<p>Insufficient structure clearance and signal sighting</p>		<p>Proposed Down Brent Curve line may encroach within the standard clearance of signal WH491 which is currently located in 10 foot between Down Reception Siding and Down Brent Curve at ELR: SPC1 5m 1670yds approximately.</p>
<p>Electrical clearances</p>		<p>The position of relatively new OLE mast does not clash with the proposed platform. However, the headspan will be across the platform. OLE structures will need to be modified at the WLO station implementation stage.</p> <p>Envisaged modifications required will include OLE insulation near platform areas, and bonding of conductive platform structures.</p>

<p>Clearances to existing line side assets</p>		<p>Clearances to existing lineside assets (i.e. location cabinets assumed to be associated with signal WH453) will need to be confirmed at next stage.</p> <p>Platform width and proposed track alignment may need to be reduced to provide sufficient clearances if required or lineside assets relocated.</p>
<p>Signal sighting</p>		<p>Existing signal WH453 located in the 6 foot between the Engineers Siding and the Up Brent Curve will need to be relocated as part of the Brent Curve lines re-signalling project (see section 6.2).</p>
<p>Redundant assets</p>		<p>Engineers Siding and any associated ancillary asset will need to be removed.</p>

<p>Asset decommission or relocation</p>		<p>GSM-R sign posts located in the 4 foot of the ES to be relocated.</p> <p>New position to be confirmed at Approval in Principle design stage.</p>
<p>Asset decommission or relocation</p>		<p>The purpose of the existing CCTV camera column and associated cabinet is not known at the time of this report. It is assumed that the camera serves as a deterrent against trespass and vandalism which are evident by the graffiti on line side assets, and fly tipping which is also a common problem in the area.</p> <p>Future requirement for this asset will need to be confirmed at the next stage.</p>

Pro’s

- 4 and 8-car train lengths can be accommodated
- Option utilises a single revenue protected station access via BXW station. If this proves inadequate in capacity terms a second access could be created direct to Geron Way by extending the bridge.
- Single span footbridge installed to provide access/egress to BXW platforms will be reduced due to island platform.
- No land take required to achieve option.
- Minimal impact to existing lineside assets (subject to verification at next development stage).

- Reduction in platform furniture required as no need for duplication due to single face platforms.

Con's

- Reduced platform area in comparison to 2no. single face options meaning more constraints for infrastructure located on and within the platforms.

9.2 Option 2 – One Single face platform - Discarded

This option proposed the installation of a single face platform with its rear to the boundary fence and platform edge served by the Engineers Siding line. The Up and Down platforms will essentially be one platform with markers to indicate the boundary of each platform. This proposal would require the complete refurbishment of the Engineers Siding line and the installation of new S&C between the Up Brent Curve and Down Brent Curve to the Engineers Siding.

This option has been discounted because it will require a complex timetabling/signalling design and that it would likely introduce significant constraint to the operations on the Brent Curve lines at a crucial location of the WLO route i.e. close proximity to Brent Curve junction. This will likely restrict the number of trains services per hour on the WLO and potentially hinder railway development opportunities further north beyond Hendon.

9.3 Option 3 – Two Single Face Platforms

This option proposes the installation of two single face platforms to serve the Up and Down Brent Curve lines. See drawing reference WLO-CAP-01000-A-DR-C-000003 Rev. P01 in Appendix A. This proposal would require permanent way alterations to the Engineers Siding, the Up Brent Curve and the Down Brent Curve. The proposed realignment of the lines would have the Up Brent Curve replacing the Engineers Siding which is to be discontinued. The Down Brent Curve line is to be routed through the existing Up Brent Curve and the existing Down Brent Curve alignment is to be removed. The Up platform is to be installed between the boundary fence line and the new Up Brent Curve alignment. The Down platform is to be installed between the Down Reception Siding and the new Down Brent Curve alignment (figures 11a & 11b).

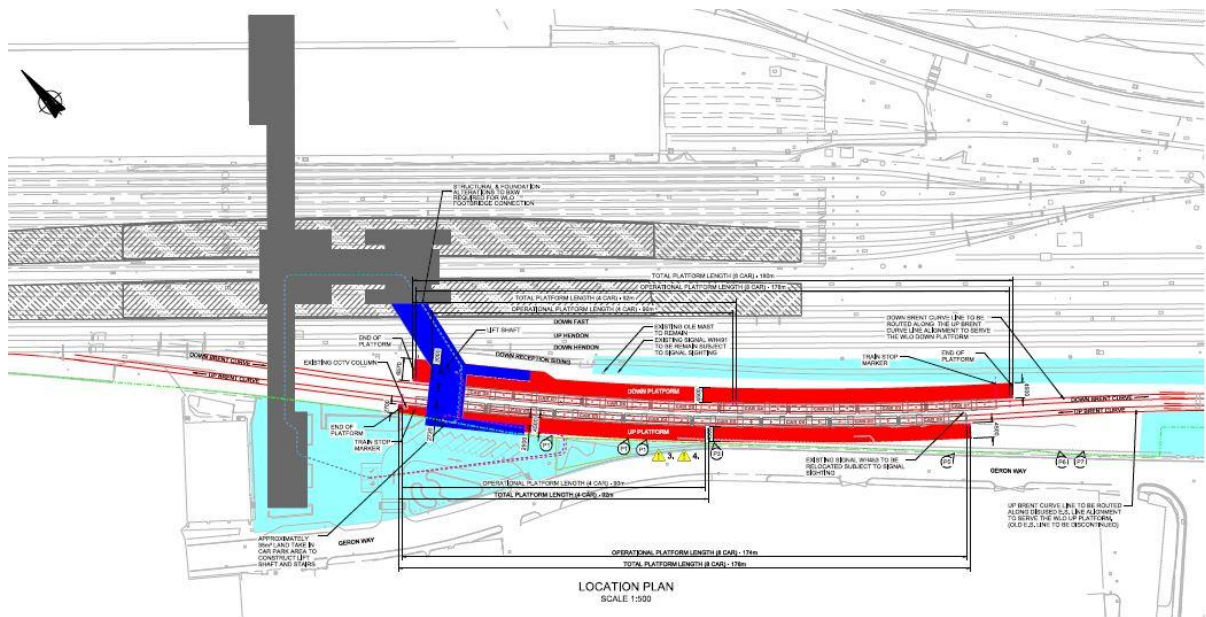

Figure 11a: snippet of option 1 platform arrangement. Full Drawing in Appendix A.

The existing turnouts for the Engineers Siding, Up Brent Curve and Down Brent Curve will need to be removed and replaced with a configuration which will provide compliant turnouts to the Option 3 proposed alignments.

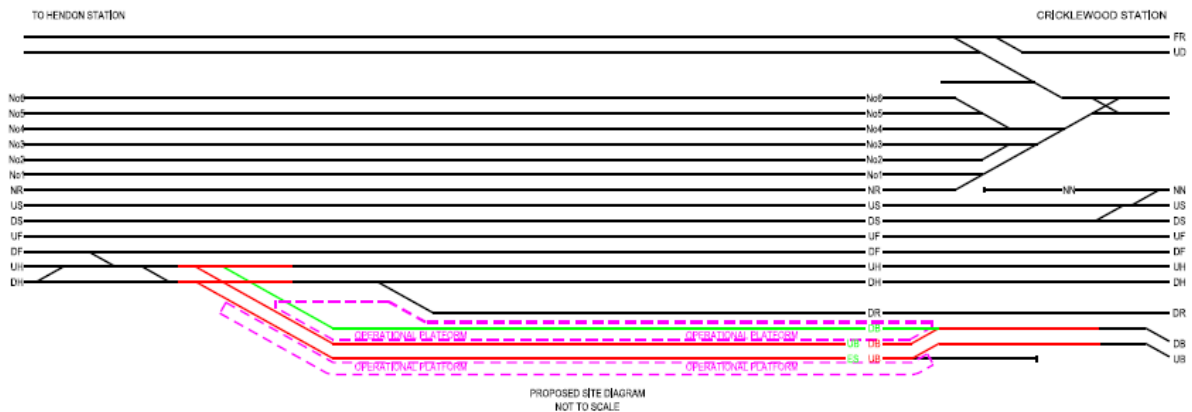

Figure 11b Option 3 PWay line diagram.

9.3.1 Track Geometry

Where a curve with radius tighter than 870 m had to be implemented, the virtual transition between these curves and a straight geometry didn't achieve a normal value of 'Rate of Change of Cant' for 30-mph, so the speed limit is to be 10-mph within those areas. These areas are near the turnouts; but a line speed of 30-mph through the platforms provides normal track parameters.

9.3.2 Platform lengths

This option achieves the minimum required platform length of 170 m for an 8-car and 4-car trainset. The proposed total platform lengths are 180 m for the 8-car length and 92 m for the 4-car length for both the Up and Down platforms. See details on drawing reference WLO-CAP-01000-A-DR-C-000003 Rev. P01 in Appendix A.

9.3.3 Platform Width

The Up platform is proposed to be 4500 mm wide. However, the platform narrows down to a width of 2700mm towards the north end due to the existing boundary constraints.

The Down platform is proposed to be 4500 mm wide. The platform widens to a width of 6570 mm towards the north end to allow for the installation of the access stairs and lift shaft.

9.3.4 Platform Access

Access to the station platforms will be through the BXW station main concourse which will have revenue protection. A new footbridge connected to the upper concourse of the BXW will provide the interchangeability between the two stations. Minor land take will be required to install new access steps and a lift shaft to the Up platform. This is due to required minimum clearance of 2500 mm between station platform structures and the platform edge. It may be possible to design the land take out at the next development stage.

Mobility impaired passengers can access the WLO platforms via the BXW footbridge and lifts to the new WLO station footbridge which will have new lift to the two platforms.



An alternative access arrangement is also available within this option. This will require the installation of new WLO station entrance with new revenue protection ticket barriers in the car park area. It will also have the benefit of providing alternative access/egress during emergency evacuation and easier access for mobility impaired passengers needing to access the WLO platforms only.



9.3.5 Affected Assets

The table below describes the impact of option 3 on the existing lineside assets. This applies to both the 8 car and 4 car trainsets.

Table 6: list of assets affected by Option 3 proposal

Asset Impact		Description
<p>Structural clash; Lift shaft / Stairs vs DNO cabinet</p>		<p>Existing Network Rail DNO cabinet within 3rd party land (car park area) to be removed by others e.g. during BXW station works.</p> <p>The cabinet will likely clash with the UP platform stairs and lift shaft works if not removed before WLO implementation stage.</p>
<p>Proximity to new Up Brent Curve alignment</p>		<p>Main cable route troughs will clash with the Up platform.</p> <p>The route will need to be diverted into a protected route possibly within the platform structure.</p>
<p>Electrical clearances</p>		<p>The position of relatively new OLE mast does not appear to clash with the proposed Up platform. However, the headspan or portal will be across the platform area.</p> <p>OLE structures will need to be modified at the WLO station implementation stage.</p> <p>Envisaged modifications required will include mast relocation, OLE insulation near platform areas, and bonding of conductive platform structures.</p>

<p>Clash with existing line side assets</p>		<p>The existing location cases associated with signal WH453 for the Up Brent Curve will need to be relocated as part of the Brent Curve lines re-signalling project (see section 6.2).</p>
<p>Signalling alteration and sighting</p>		<p>The existing signal WH453 for the Up Brent Curve will need to be relocated as part of the Brent Curve lines re-signalling project (see section 6.2).</p>
<p>Redundant assets</p>		<p>Engineers Siding and any associated ancillary asset will need to be removed.</p>

<p>Asset decommission or relocation</p>		<p>GSM-R sign posts located in the 4 foot of the ES to be relocated.</p> <p>New position to be confirmed at Approval in Principle design stage.</p>
<p>Asset decommission or relocation</p>		<p>The purpose of the existing CCTV camera column and associated cabinet is not known at the time of this report. It is assumed that the camera serves as a deterrent against trespass and vandalism which are evident by the graffiti on line side assets, and fly tipping which is also a common problem in the area.</p> <p>Future requirement for this asset will need to be confirmed at the next stage.</p>

9.3.6 Platform drainage

It is assumed that platform drainage will require a separate network with new outfall and consent to discharge to the West of WLO Platforms.

Pro's

- 4 and 8-car train lengths can be accommodated
- Option utilises single gate line for revenue protection via BXW station. If a second access is required to the WLO platforms this can be facilitated easily at low cost.

Con's

- Minor land take required to achieve option.
- Existing line side assets adjacent the boundary line will need to be modified to achieve option. These are fairly extensive and include key route signalling and telecoms assets as well as the autotransformer cabling being relocated to make way for the Brent Cross West station
- A longer footbridge and two sets of lifts and stairs are needed due to separate platforms
- Additional costs associated with two single platforms

10 Connection to BXW station

10.1 Footbridge Concept Proposal

Based on inspection it appears that a new footbridge connection can be made to the west side of the upper concourse to create the interchange with the potential WLO station. The ideal location for the connection is depicted in figure 12. This results in a 'wide' bridge which will be an extension to the BXW concourse.

This effectively mirrors the concourse arrangement between the existing slow and fast line platforms. At this design stage it is assumed that this will have sufficient capacity for the anticipated volume of passengers to the WLO line platforms i.e. approximately 10% increase on the design year values for Brent Cross west station of 5m entries and exits per annum).

The key area will be the access across the lifts and stairs to the fast line platforms. However, it should be noted that as the fast line platforms will be out of use the majority of the time there are fewer issues associated with the new access for passengers to the WLO platforms crossing the access/egress to the fast line platforms. When the fast line platforms are in use (when the slow lines are closed) this will typically be at periods of low demand and it will provide a direct interchange connection between the two.

At the next design stage (i.e. Options selection stage) it will be necessary to undertake pedestrian

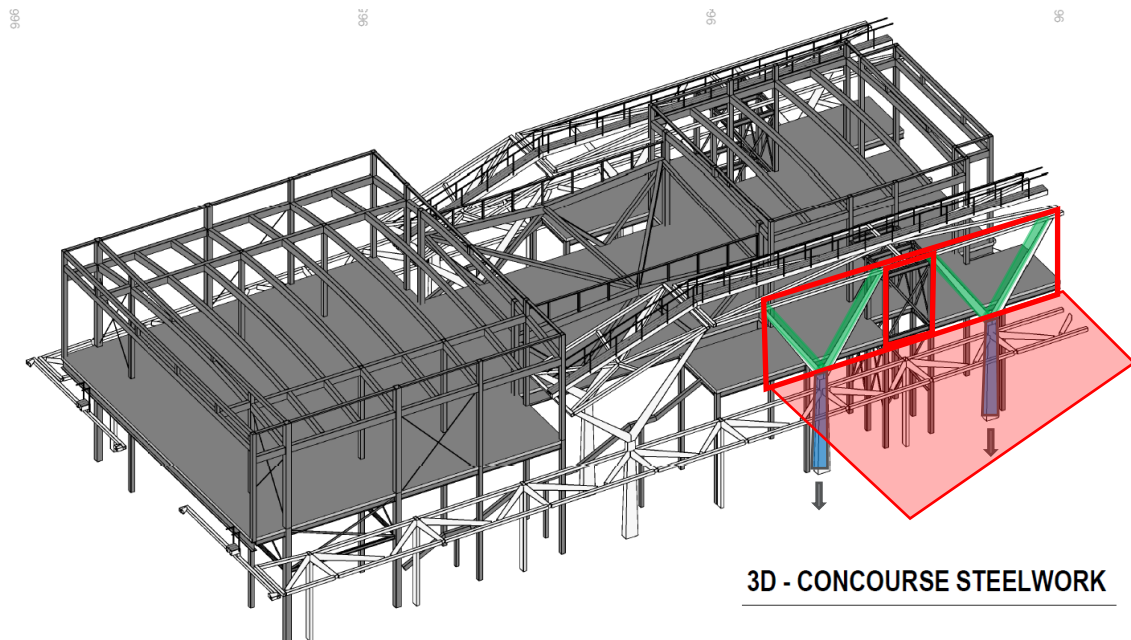

Figure 12: interchange connection to BXW station.

flow modelling based on peak station demand to confirm all the access routes will meet normal peak usage, periods of perturbation of train service and emergency evacuation. This will include the lifts and stairs to the new platforms. In both options considered a second access could be provided on Geron Way if capacity proves to be an issue.

The connection will impact on the BXW station west side elevation architectural features by modifying the lower and upper canopy structures as follows:

- Two Y-frame support struts will need to be removed and replaced with new structural arrangement which will allow access to the concourse and provide support to the upper canopy. The new structure can be designed to be sympathetic to the rest of the station architectural features subject to acceptance by the asset owner/manager.
- It is highly likely that the Y-frame columns will need replacing with robust sections to transfer the new footbridge loading and any load part changes from the BXW structure to the foundation.

The AIP foundation design will also need to be revised to take account of the new loadings.

10.2 Passive provision and early infrastructure investment

10.2.1 Interchange Connections

The footbridge connection is crucial to the interchangeability between the BXW and WLO stations and early investment to make provision for the potential future connection loadings in the BXW structure will result key significant benefit as follows:

- Minimise future costs and disruption to train services (reduce length of line closures) associated with the installation of the WLO bridge connection in the future, noting in particular it is adjacent the down fast line platform.
- A sympathetic design approach to current station architecture.

The logic for the design alterations to be made at the detailed design stage of the BXW station project is envisage as follows:

- Design a new footbridge to connect to the area identified based on the BXW station footbridge design capacity; assumed worse case due to mixed use by commuters and general public.
- Determine a suitable support arrangement relative to the BXW station building structure i.e. future permanent state e.g. proposed alterations can be sympathetic to the station architecture.
- Determine alterations to existing design to achieve the least operationally disruptive installation sequence e.g. providing and installing columns and foundations with greater loading capacity may avoid excavation works at platform level in the future. This logic is based on the following suggested construction sequence is provided as follows:
 - Temporarily prop upper and lower canopy at designed support points. Props load paths to be diverted through existing foundations.
 - Remove canopy permanent supports in designed sequence.
 - Insert new canopy and footbridge support members or frames and connect to pre-designed connection points.

- Connect new footbridge span.

10.2.2 Land Requirements

A small area of land adjacent to the platforms which is being acquired by the Council for Brent Cross West Station will need to be reserved for either option. This is pending the outcome of the Option selection study at the next development stage.

10.3 Cost Estimation

There will be two costs associated with passive provision and early investment for the alterations to the existing BXW station design. One is the cost for modifying the existing architectural, structural and civil engineering design. The second is the construction cost for these alterations.

10.3.1 Design Cost Estimation

The design cost will essentially be made up of the design and project management services fees to cover variations to the existing approved outline designs (i.e. Forms F001, F002, and F004) and the proposed design alterations as discussed in section 10.2.1. It is anticipated that this would be in the form of a contract variation to the BXW station design and build contract.

Design only alterations has been estimated to be about circa £30,000 based on a project team made up of Architects, Structural and Civil engineers working with the assumptions that:

- the WLO footbridge capacity will be similar to the BXW footbridge,
- the WLO footbridge connections will be to design to existing structure nodes therefore, no new column positions will be required,
- Uniform level between the concourse and the WLO footbridge can be achieved without alterations to BXW track and platform vertical clearances, and
- Use of similar construction type i.e. steelwork construction.

The typical deliverables for the design only alterations are:

- Addenda to existing Forms F001, F002, and F004.
- Modified CAD model for structures only.
- Designer's Risk Assessment
- Scoping calculations
- Specifications of structural members replacement/ upgrade
- Pile foundation design.

10.3.2 Construction Cost Estimation

The cost for the installation of the passive provisions and early investment elements will need to be discussed in detail with the BXW contractor. Although, this cost will be largely from construction materials it is possible the other influencing factors could drive cost e.g. availability and lead times for materials and plants, construction methodology etc. There is an opportunity for early contractor involvement on this subject to identify areas of opportunities and risks for efficient delivery.

11 Conclusion and Recommendations

This feasibility study has presented design options for WLO platforms at Brent Cross West based on anticipated rolling stock and standard requirements for interface between station platforms, track and trains. At the next design stage additional works will need to be carried out in order to confirm that the arrangements proposed in the options are suitable for further development e.g. station capacity assessment and modelling will be required to confirm the station access/egress and platform widths subject to passenger demand. It is understood but not discussed in this report that agreements concerning station operations, interface with the BXW operator and revenue protection among other matters may need to be concluded prior to completion of the station capacity assessment works as these may determine how the WLO station proposal will impact the overall station operation and the location of station entrance and exit points.

In addition to the above there is a need to gain necessary planning consents for the development as well as approvals from Network Rail and the relevant rail operators.

A number of assumptions were made in the development of the study which will require validation at the next stage in line with the overall WLO proposals. A key assumption is the rolling stock to be used on the WLO lines. Therefore, this feasibility study will require validations after the selection of a preferred rolling stock.

This study has identified two feasible options for new platforms for up to 8 car trains at Brent Cross West to serve the proposed West London Orbital (WLO) service with a direct connection via a wide footbridge to the main station concourse.

The platforms would be situated on the Brent curve. One option is for a single island platform and the second for two single face platforms. The second option is more expensive due to the separate platforms and additional lifts and stairs required. It will also impact more significantly on existing sensitive lineside infrastructure at this location. Both options could be configured to provide a second access to Geron way if this is required for capacity or other reasons, albeit the second option already includes the necessary vertical circulation.

The study has also identified some additional structural provision which could be made to the Brent Cross West Station design to facilitate the future footbridge installation linking the WLO platforms to the main concourse. This is common to both options and is recommended that this structural provision is made in the station detailed design to minimise the need for more significant works in terms of costs and service disruption if this has to be retrofitted later.

At the next design stage, the final sizing of the platforms and access arrangements can be confirmed. It is recommended that a stakeholder consultation is carried out to determine any specific requirements for the development of a comprehensive remit.

APPENDIX A – Drawings

APPENDIX B – Risk Assessments and Hazard Records

B01 - CDM HAZARD/RISK IDENTIFICATION SHEET

Project Description	West London Orbital (WLO) - Brent Cross West Interchange Station Feasibility Study	Project Ref No	CS/097901-01	Stage	GRIP 2
----------------------------	--	-----------------------	--------------	--------------	--------

Date of Latest Update	28/06/2019	Prepared by	Augustus Orejobi	Checked by	James Willis
------------------------------	------------	--------------------	------------------	-------------------	--------------

Location of other information provided in accordance with Regulation 9(4)	TBC
--	-----

FORSEEABLE HAZARD/RISK IDENTIFIED [That has potential to cause harm to those constructing, repairing / maintaining, cleaning, demolishing or using the structure]	HAZARD/RISK APPLIES DURING					COMMENTS: Provide; <ul style="list-style-type: none"> the actions taken by the designer to eliminate risk, the reasons why remaining risks cannot be eliminated, an explanation of the reduction and controls necessary and the significance of the residual risk; any special instructions (e.g. to include any pre-construction information) 	Residual Risk still present? YES / NO
	Construction	Maintenance	Cleaning	In Use	Demolition		

<p>1</p>	<p>Train passing signals at danger in the area of the potential WLO station i.e. due to proposed works obscuring existing signals, drivers and signaller not familiar with new signalling operations, Track gradient towards Brent Curve junction</p>				<p>✓</p>		<p>The signalling in and around the potential BXW WLO station will need to be to mitigate the possibility of Signal Passed at Danger (SPAD). This could include overrun detection and management, predetermined overrun protection Other signal affected will need to be assessed through signal sighting procedure at AIP design stage. Train detection, protection, and warning system need to be considered at next stage designers. Driver and signaller training to be considered prior to handback to asset manager. Further collaboration with TOCs and FOCs required at next development stages. Track gradient risk assessment to be carried out at next stage to determine suitable track gradient and other mitigations if required.</p>	<p>Yes</p>
<p>2</p>	<p>Invasive species: Previous ecology report produced by Capita has identified the presence of Japanese Knotweed in the vicinity of the proposed works. If not eradicated could cause damage to new structures and substructures.</p>	<p>✓</p>		<p>✓</p>	<p>✓</p>		<p>The impact of the invasive species has been discussed within this feasibility study report. This will need to be taken into consideration when developing the programme for option selection report due to long lead time for eradication from site i.e. up to 6 months typically.</p>	<p>Yes</p>

3	<p>Striking buried or overhead services;</p> <p>The proposed site of the potential WLO station is within the railway boundaries therefore, existing buried and overhead services are expected to be present e.g.</p> <p>OLE: overhead wires, bond cables at ground level.</p> <p>Buried 39 dia. Sewer piper (exact position unknown) information obtained from NHD.</p>	✓					<p>A buried services search and site topographic survey are to be carried out at the next development stage to identify any potential clash or interface.</p> <p>Where relevant to the design development, the routes of services are to be modified or protected.</p> <p>A competent designer/contractor is expected to be aware of this risk.</p> <p>Nevertheless, hazard warning sign has been provided on drawing to warn lineside operatives that may be involved in enabling works or site reconnaissance of the risks.</p>	Yes
4	<p>Exposure to hazardous substance or objects on site e.g. biohazards, sharps and needles:</p> <p>Fly tipping is a common problem in the area of the potential WLO station. It is envisaged that the problem will be cease following the development of the BXW station. However, site operatives may still encounter harmful objects or substances during site investigation works e.g. surveys, walkout etc.</p>	✓				✓	<p>PPE must be worn when visiting site.</p> <p>SSOW for managing identified hazardous substances and objects must be put in place prior to site visits.</p> <p>A competent designer/contractor is expected to be aware of this risk.</p> <p>Nevertheless, hazard warning sign has been provided on drawing to warn lineside operatives that may be involved in enabling works or site reconnaissance of the risks.</p>	Yes

NOTE: those residual risks that are not likely to be apparent to a competent contractor / cleaner / maintainer / user / demolisher of the structure must be forwarded to the Principal Designer for inclusion in the pre-construction information.

B02 – National Hazard Directory Record

Search Criteria: ELR(s) = BDH; Mileage From = 0.0000; Mileage To = 1.0000							
Date: 28/06/2019							
ELR	ELR Name	Mileage From	Mileage To	Hazard Description	Local Name	Track ID	Free Text
BDH	BRENT CURVE JN - DUDDING HILL JN	0.0000	0.1188	Invasive / Injurious Plants		Up Slow	Japanese knotweed at this mileage in the cess
BDH	BRENT CURVE JN - DUDDING HILL JN	0.0000	0.1188	Invasive / Injurious Plants		Down Slow	Japanese knotweed at this mileage in the cess
BDH	BRENT CURVE JN - DUDDING HILL JN	0.0358	0.0358	Authorised Access Point - Vehicle	Geron Way	Up Main/Fast	Danger Overhead Live Wires, no parking at any time. Access via Geron Way <Post Office Sidings>
BDH	BRENT CURVE JN - DUDDING HILL JN	0.0440	0.0650	Restricted Clearance	Limited Clearance at Retaining Wall	Up Siding	ZIAR Ref No_266586_ Interim Reference No_HZ_4017 _Notes:

Search Criteria: ELR(s) = BDH; Mileage From = 0.0000; Mileage To = 1.0000							
Date: 28/06/2019							
BDH	BRENT CURVE JN - DUDDING HILL JN	0.0441	0.0640	Restricted Clearance	Limited Clearance at Retaining Wall	Down Siding	ZIAR Ref No_266587_ Interim Reference No_HZ_4018 _Notes:
BDH	BRENT CURVE JN - DUDDING HILL JN	0.0672	0.0836	Buried Electrical Cables	Brent sidings		Buried 400kv electrical cable within 3.5 metre tunnel running across track @ 0.0672 miles then alongside track and sidings in direction of increasing mileage to Br. No. 2 <Edgware Road>. <Wayleave>
BDH	BRENT CURVE JN - DUDDING HILL JN	0.0776	0.0776	Authorised Access Point - Vehicle	Brent Curve Old Signal Box	Down Main/Fast	Needs steps and handrail
BDH	BRENT CURVE JN - DUDDING HILL JN	0.0836	0.0836	Restricted Clearance	Limited Clearance at Bridge 2	Up Siding	ZIAR Ref No_266588_ Interim Reference No_HZ_4019 _Notes:
BDH	BRENT CURVE JN - DUDDING HILL JN	0.0836	0.0836	Restricted Clearance	Limited Clearance at Bridge 2	Down Siding	ZIAR Ref No_266588_ Interim Reference No_HZ_4019 _Notes:

Search Criteria: ELR(s) = SPC1; Mileage From = 5.0000; Mileage To = 7.0000							
Date: 28/06/2019							
ELR	ELR Name	Mileage From	Mileage To	Hazard Description	Local Name	Track ID	Free Text
SPC 1	ST PANCRAS - BEDFORD	0.0000	5.1430	Hazard-Clearance	Restricted Warning Times	Unknown	ZIAR Ref No_271897_ Interim Reference No_HZ_10415 _Notes: Sourced from Issue 1. Dated 25/3/97. of the Hazards Directory
SPC 1	ST PANCRAS - BEDFORD	0.0000	50.0000	25Kv Overhead Electrification	25 KV Overhead Line Equipment	All/Multiple Tracks	ZIAR Ref No_271894_ Interim Reference No_HZ_10412 _Notes: Sourced from Issue 1. Dated 25/3/97. of the Hazards Directory
SPC 1	ST PANCRAS - BEDFORD	0.0000	144.1496	Road/Rail Noise	Beware of Noise		ZIAR Ref No_271893_ Interim Reference No_HZ_10411 _Notes: Noise from Wind, Road Traffic and Low Flying Aircraft. Sourced from Issue 1. Dated 25/3/97. of the Hazards Directory
SPC 1	ST PANCRAS - BEDFORD	3.0770	7.0000	Invasive / Injurious Plants		All/Multiple Tracks	Japanese knotweed at this mileage in cess on both sides
SPC 1	ST PANCRAS - BEDFORD	5.0000	5.0099	Restricted Clearance	Limited Clearance at Retaining Wall		ZIAR Ref No_266374_ Interim Reference No_HZ_3805 _Notes:

Search Criteria: ELR(s) = SPC1; Mileage From = 5.0000; Mileage To = 7.0000							
Date: 28/06/2019							
SPC 1	ST PANCRAS - BEDFORD	5.0000	6.0000	Invasive / Injurious Plants	Cricklewood Sidings	All/Multiple Tracks	Japanese knotweed at this mileage in the cess and sidings and should be treated aa per NWR environmental guidance note JK02. IT SHOULD NOT BE FLAILED OR STRIMMED
SPC 1	ST PANCRAS - BEDFORD	5.0010	5.0010	Restricted Clearance	Signal No. WH446 - Cricklewood		ZIAR Ref No_281610_ Interim Reference No_HZ_23520 _Notes: Line to Which Signal Applies Up Hendon WH 2 Panel: 00-48577, Distance Between Lines 8 9ç. 4 4ç to adjacent line; l/spd 110mph., Prohibited to Hand Signalmen?. Y/N. = Yes, Prohibit to Drivers?. Y/N. = Yes
SPC 1	ST PANCRAS - BEDFORD	5.0039	5.0356	Electrification	HV 25kV Cable F08/01A TO F08/17A	All/Multiple Tracks	New 25kV 400sq/mm insulated cable installed as part of the OLE ATF route. Areas such as bridges,tunnels, signal gantries and footbridges all cabled. Cable terminates either side on structure anchors and is troughed between. Cable is placed in ducts through, or troughing around platforms. Any invasive work within 1M will require HV assessment.
SPC 1	ST PANCRAS - BEDFORD	5.0058	5.0367	Electrification	HV 25kV Cable F08/01B TO F08/18	All/Multiple Tracks	New 25kV 400sq/mm insulated cable installed as part of the OLE ATF route. Areas such as bridges,tunnels, signal gantries and footbridges all cabled. Cable terminates either side on structure anchors and is troughed between. Cable is placed in ducts through, or troughing around platforms. Any invasive work within 1M will require HV assessment.

Search Criteria: ELR(s) = SPC1; Mileage From = 5.0000; Mileage To = 7.0000							
Date: 28/06/2019							
SPC 1	ST PANCRAS - BEDFORD	5.0069	5.0099	Restricted Clearance	Limited Clearance at Retaining Wall		ZIAR Ref No_266375_ Interim Reference No_HZ_3806 _Notes:
SPC 1	ST PANCRAS - BEDFORD	5.0099	5.0099	Restricted Clearance	Limited Clearance at Under Bridge 40	Up Slow	ZIAR Ref No_266376_ Interim Reference No_HZ_3807 _Notes:
SPC 1	ST PANCRAS - BEDFORD	5.0099	5.0099	Authorised Access Point - Pedestrian	UB40 Cricklewood Lane <Cricklewood Station>	All/Multiple Tracks	Notes: Access via Cricklewood Station. Red Zone Prohibited.
SPC 1	ST PANCRAS - BEDFORD	5.0099	5.0099	Restricted Clearance	Limited Clearance at Under Bridge 40	Down Main/Fast	ZIAR Ref No_266376_ Interim Reference No_HZ_3807 _Notes:
SPC 1	ST PANCRAS - BEDFORD	5.0100	5.0236	Red Zone Working Prohibited	Cricklewood Stn	All/Multiple Tracks	Tracks: 1200, 2200, 2100, 1100. No POS as per RT/LS/S/019. Rimini: DVD 248/04
SPC 1	ST PANCRAS - BEDFORD	5.0104	5.0104	Buried Water Main	A407 Cricklewood Lane <Br. No. 40>		2 water mains <1 X 12", 1 X 24"> buried in road under bridge No. 40.

Search Criteria: ELR(s) = SPC1; Mileage From = 5.0000; Mileage To = 7.0000							
Date: 28/06/2019							
SPC 1	ST PANCRAS - BEDFORD	5.0104	5.0104	Buried Foul Water Service	A407 Cricklewood Lane <Br. No. 40>		2 X Public surface water sewers and 1 X Public foul sewer buried in road under bridge No. 40.
SPC 1	ST PANCRAS - BEDFORD	5.0143	5.0143	Hazard Associated with Bridge	STRUCTURE SPC1-41 - STATION SUBWAY CRICKLEWOOD <CL	All/Multiple Tracks	Structure SPC1-41 - Low Parapet/Handrail. Potential risk of falling
SPC 1	ST PANCRAS - BEDFORD	5.0143	5.0243	Restricted Clearance	Limited Clearance at Retaining Wall		ZIAR Ref No_266377_ Interim Reference No_HZ_3808 _Notes:
SPC 1	ST PANCRAS - BEDFORD	5.0150	5.0180	Restricted Clearance	Limited Clearance at Retaining Wall		ZIAR Ref No_266378_ Interim Reference No_HZ_3809 _Notes:
SPC 1	ST PANCRAS - BEDFORD	5.0151	5.0151	Authorised Access Point - Pedestrian	Cricklewood Station	All/Multiple Tracks	Off Cricklewood Lane via platforms and subway. Access to Cricklewood Down sidings and Authorised Walking Route to Depots and signal box from Up Slow platform north end.
SPC 1	ST PANCRAS - BEDFORD	5.0198	5.0198	Preserved Tree (TPO)	Tree Preservation Order.		ZIAR Ref No_273193_ Interim Reference No_HZ_15103 _Notes: Group Of Trees On Land Between Westbere Road And The Railway. Tpo No.C73. Part Of The Land Sold On

Search Criteria: ELR(s) = SPC1; Mileage From = 5.0000; Mileage To = 7.0000							
Date: 28/06/2019							
							1.6.83 To Lb Of Camden. Heritage Record No: HR06428/7001
SPC 1	ST PANCRAS - BEDFORD	5.0198	5.0198	Hazard-Structural	Cricklewood (Property Ref No:- 064289000000)		
SPC 1	ST PANCRAS - BEDFORD	5.0198	5.0198	Authorised Walking Route	Cricklewood P Way Cabin	All/Multiple Tracks	ZIAR Ref No_268380_ Interim Reference No_HZ_5863 _Notes: Track Staff. Use the concrete path which leads from the North End of the Down Fast Platform which crosses the Hendon Lines and Cricklewood Curve branch on a purpose made surface., Route Sponsor; EIMU, Issue Date; 01/10/95 NOTE: THE MILEAGES USED HERE ARE ONLY APPROXIMATE.
SPC 1	ST PANCRAS - BEDFORD	5.0198	5.0198	Authorised Access Point - Pedestrian	Cricklewood Sidings Walking Route	All/Multiple Tracks	Up Slow and Down Sidings; for all other lines see Cricklewood Station. Walking Route Inspection MST Required
SPC 1	ST PANCRAS - BEDFORD	5.0440	5.0440	Authorised Access Point - Vehicle	Cricklewood Stn Nth,Jewsons;access via Depot Appro	All/Multiple Tracks	Via Depot Approach off Edgware Road. Double gates to trackside; vehicle parking outside the gates. Access to the Down side;Down Cricklewood Curve and Down Hendon.
SPC 1	ST PANCRAS - BEDFORD	5.0618	5.0618	Authorised Access Point - Vehicle	Cricklewood former PWay Depot via Roman Road	All/Multiple Tracks	Double gates to trackside; vehicle parking inside the gates. Up Cricklewood Curve and Down Hendon.

Search Criteria: ELR(s) = SPC1; Mileage From = 5.0000; Mileage To = 7.0000							
Date: 28/06/2019							
SPC 1	ST PANCRAS - BEDFORD	5.0639	5.0639	Buried Water Main	Near 5.25 Mile Post		1 X 42" diameter and 1 X 48" diameter water mains under tracks approx 200yds from 5.25 MP in direction of increasing mileage.
SPC 1	ST PANCRAS - BEDFORD	5.0740	5.0780	Buried Foul Water Service	21 Diameter Concrete sewer		ZIAR Ref No_279148_ Interim Reference No_HZ_21058 _Notes: Laid by Herdon Corporation, - Railtrack Property Land Plan No; 235
SPC 1	ST PANCRAS - BEDFORD	5.0787	5.0787	Buried & Overhead Electric Cable	Electric Cable		ZIAR Ref No_279149_ Interim Reference No_HZ_21059 _Notes: Laid by E. E. B., - Railtrack Property Land Plan No; 235
SPC 1	ST PANCRAS - BEDFORD	5.0800	5.0851	Electrification	HV 25kV Cable F08/34A TO F08/35B	All/Multiple Tracks	New 25kV 400sq/mm insulated cable installed as part of the OLE ATF route. Areas such as bridges,tunnels, signal gantries and footbridges all cabled. Cable terminates either side on structure anchors and is troughed between. Cable is placed in ducts through, or troughing around platforms.Any invasive work within 1M will require HV assessment.
SPC 1	ST PANCRAS - BEDFORD	5.0924	5.0924	Hazard Associated With Culvert	SPC1/41B	All/Multiple Tracks	Culvert/CUL - Brick

Search Criteria: ELR(s) = SPC1; Mileage From = 5.0000; Mileage To = 7.0000							
Date: 28/06/2019							
SPC 1	ST PANCRAS - BEDFORD	5.1050	5.1050	Restricted Clearance	Signal No. WH462 - Brent		ZIAR Ref No_281611_ Interim Reference No_HZ_23521_Notes: Line to Which Signal Applies Up Hendon WH 2 Panel: 00-48577, Distance Between Lines 2500mm, Prohibited to Hand Signalmen?. Y/N. = Yes, Prohibit to Drivers?. Y/N. = Yes
SPC 1	ST PANCRAS - BEDFORD	5.1056	5.1056	Hazard Associated With Culvert	SPC1/41C	All/Multiple Tracks	Culvert/CUL - Brick
SPC 1	ST PANCRAS - BEDFORD	5.1063	5.1063	Buried & Overhead Electric Cable	Electric Cable		ZIAR Ref No_279150_ Interim Reference No_HZ_21060_Notes: Laid over bridge by Willesden U. D. C., - Railtrack Property Land Plan No; 235
SPC 1	ST PANCRAS - BEDFORD	5.1072	5.1072	Buried Water Main	Water Pipe		ZIAR Ref No_279151_ Interim Reference No_HZ_21061_Notes: Br. No. 2, Pipe bridge constructed over railway by Thames Water, - Railtrack Property Land Plan No; 235
SPC 1	ST PANCRAS - BEDFORD	5.1100	5.1100	Asbestos Hazard	Cricklewood SB	All/Multiple Tracks	Asbestos containing material present. Contact Zone Building Surveyor for further details.
SPC 1	ST PANCRAS - BEDFORD	5.1101	5.1101	Buried Foul Water Service	Near 5.75 Mile Post		Foul sewer under tracks approx 220yds from 5.75 mile post in direction of decreasing mileage.

Search Criteria: ELR(s) = SPC1; Mileage From = 5.0000; Mileage To = 7.0000							
Date: 28/06/2019							
SPC 1	ST PANCRAS - BEDFORD	5.1113	5.1146	Electrification	HV 25kV Cable F09/02A TO F09/03A	Down Goods	New 25kV 400sq/mm insulated cable installed as part of the OLE ATF route. Areas such as bridges, tunnels, signal gantries and footbridges all cabled. Cable terminates either side on structure anchors and is troughed between. Cable is placed in ducts through, or troughing around platforms. Any invasive work within 1M will require HV assessment.
SPC 1	ST PANCRAS - BEDFORD	5.1320	5.1320	Restricted Clearance	Signal No. WH39 - Cricklewood		ZIAR Ref No_281612_ Interim Reference No_HZ_23522 _Notes: Line to Which Signal Applies Down Fast, Distance Between Lines 2500mm, Prohibited to Hand Signalmen?. Y/N. = Yes, Prohibit to Drivers?. Y/N. = No
SPC 1	ST PANCRAS - BEDFORD	5.1354	5.1364	Arches or other Buildings	CRICKLEWOOD		35 METER HIGH AD2506L LATTICE TOWER AND TWO ASSOCIATED EQUIPMENT CABINS. THE TOWER CARRIES 6 SECTORED ANTENNAE, 6 LNAs AND 20 MICROWAVE DISHES. A HIGH PALLISADE SECURITY FENCE SURROUNDS THE ABOVE.
SPC 1	ST PANCRAS - BEDFORD	5.1386	6.0088	Bi-directional Working	Bi-directional Line - Down Hendon		ZIAR Ref No_271903_ Interim Reference No_HZ_10421 _Notes: Sourced from Issue 1. Dated 25/3/97. of the Hazards Directory
SPC 1	ST PANCRAS - BEDFORD	5.1452	6.0484	Landfill Gases	Claremont Way, Brent.		LANDFILL GAS. This stretch of railway has been identified as being at risk from the migration of landfill gasses. Appropriate precautions should be taken. For further

Search Criteria: ELR(s) = SPC1; Mileage From = 5.0000; Mileage To = 7.0000							
Date: 28/06/2019							
							information please contact nationalminingengineer@networkrail.co.uk
SPC 1	ST PANCRAS - BEDFORD	5.1481	5.1481	Authorised Access Point - Vehicle	Geron Way, Post Office Sidings	All/Multiple Tracks	Double gates to trackside; vehicle parking outside the gates. Up & Dn Brent Curve and Down Hendon.
SPC 1	ST PANCRAS - BEDFORD	5.1543	5.1560	Buried & Overhead Electric Cable	11 Kv U/G Electric Cable		ZIAR Ref No_279152_ Interim Reference No_HZ_21062 _Notes: Laid by E. E. B., - Railtrack Property Land Plan No; 235
SPC 1	ST PANCRAS - BEDFORD	5.1606	13.0550	Hazard- Clearance	Restricted Warning Times		ZIAR Ref No_271904_ Interim Reference No_HZ_10422 _Notes: Sourced from Issue 1. Dated 25/3/97. of the Hazards Directory
SPC 1	ST PANCRAS - BEDFORD	5.1722	5.1722	Authorised Access Point - Vehicle	Cricklewood Sidings, Signal Box & P Way Depot	Up Siding	Double gates with vehicle parking inside the gates.
SPC 1	ST PANCRAS - BEDFORD	5.1740	5.1740	Authorised Access Point - Vehicle	Cricklewood Sidings Vehicle Access Route	All/Multiple Tracks	Vehicle access road from Cricklewood Station to Cricklewood Signalbox.
SPC 1	ST PANCRAS - BEDFORD	6.0000	6.0001	Invasive / Injurious Plants		Down Main/Fast	Japanese knotweed at this mileage in the Down Main/Fast Cess

Search Criteria: ELR(s) = SPC1; Mileage From = 5.0000; Mileage To = 7.0000							
Date: 28/06/2019							
SPC 1	ST PANCRAS - BEDFORD	6.0023	6.0023	Buried Foul Water Service	39 Diameter Sewer		ZIAR Ref No_279156_ Interim Reference No_HZ_21066 _Notes: Laid by Hendon U. D. C., Br. No. 44, - Railtrack Property Land Plan No; 235
SPC 1	ST PANCRAS - BEDFORD	6.0200	6.0200	Buried & Overhead Electric Cable	Electric Cable		ZIAR Ref No_279153_ Interim Reference No_HZ_21063 _Notes: Laid by Hendon B. C., - Railtrack Property Land Plan No; 235
SPC 1	ST PANCRAS - BEDFORD	6.0333	6.0333	Buried & Overhead Electric Cable	Electric Cable		ZIAR Ref No_279154_ Interim Reference No_HZ_21064 _Notes: Laid by A. E. Lewis & Son, - Railtrack Property Land Plan No; 235
SPC 1	ST PANCRAS - BEDFORD	6.0342	6.0396	Electrification	HV 25kV Cable F09/34A TO F10/01A	Down Goods	New 25kV 400sq/mm insulated cable installed as part of the OLE ATF route. Areas such as bridges,tunnels, signal gantries and footbridges all cabled. Cable terminates either side on structure anchors and is troughed between. Cable is placed in ducts through, or troughing around platforms.Any invasive work within 1M will require HV assessment.
SPC 1	ST PANCRAS - BEDFORD	6.0440	6.0440	Authorised Access Point - Vehicle	PC World <Staples Corner Retail Park>	Down Goods	Parking outside gates in PC World car park. Strail RRAP on Down Hendon.

Search Criteria: ELR(s) = SPC1; Mileage From = 5.0000; Mileage To = 7.0000							
Date: 28/06/2019							
SPC 1	ST PANCRAS - BEDFORD	6.0440	6.0440	Authorised Access Point - Vehicle	Cricklewood Signalbox	Unknown	Danger Overhead Live Wires. Parking for 20+ vehicles. Down Hendon Line
SPC 1	ST PANCRAS - BEDFORD	6.0449	6.0449	Restricted Clearance	Signal No. WH468 - Brent Viaduct		ZIAR Ref No_281613_ Interim Reference No_HZ_23523 _Notes: Line to Which Signal Applies Up Hendon WH 3 Panel: 00-48578, Distance Between Lines 2500mm, Prohibited to Hand Signalmen?. Y/N. = Yes, Prohibit to Drivers?. Y/N. = Yes
SPC 1	ST PANCRAS - BEDFORD	6.0461	6.0461	Buried Water Main	A406 North Circular <Br. No. 42A>		24" diameter water main in bridge No. 42A.
SPC 1	ST PANCRAS - BEDFORD	6.0461	6.0461	Buried Foul Water Service	A406 North Circular <Br. No. 42A>		1 X Public surface water sewer and 1 X abandoned sewer in bridge No. 42A.
SPC 1	ST PANCRAS - BEDFORD	6.0462	6.0462	Restricted Clearance	Limited Clearance at Bridge 42A	Up Slow	ZIAR Ref No_266379_ Interim Reference No_HZ_3810 _Notes:
SPC 1	ST PANCRAS - BEDFORD	6.0462	6.0462	Buried Foul Water Service	A406 Viaduct <Br. No. 43>		2 X Public surface water sewers and 2 X Public foul sewers under bridge No. 43.

Search Criteria: ELR(s) = SPC1; Mileage From = 5.0000; Mileage To = 7.0000							
Date: 28/06/2019							
SPC 1	ST PANCRAS - BEDFORD	6.0462	6.0462	Hazard Associated With Bridge	STRUCTURE SPC1-43 - RBE_WELSH HARP-A406 AND RIVER	All/Multiple Tracks	Structure SPC1-43 - Low Parapet/Handrail. Potential risk of falling
SPC 1	ST PANCRAS - BEDFORD	6.0462	6.0462	Restricted Clearance	Limited Clearance at Bridge 42A	Down Main/Fast	ZIAR Ref No_266379_ Interim Reference No_HZ_3810 _Notes:
SPC 1	ST PANCRAS - BEDFORD	6.0462	6.0682	Restricted Clearance	Limited Clearance at Bridge Viaduct 43	Up Slow	ZIAR Ref No_266380_ Interim Reference No_HZ_3811 _Notes:
SPC 1	ST PANCRAS - BEDFORD	6.0462	6.0682	Restricted Clearance	Limited Clearance at Bridge Viaduct 43	Down Main/Fast	ZIAR Ref No_266380_ Interim Reference No_HZ_3811 _Notes:
SPC 1	ST PANCRAS - BEDFORD	6.0494	6.0667	Red Zone Working Prohibited	Welsh Harp Viaduct	All/Multiple Tracks	Tracks: 2100, 2200, 2300, 1100, 1200, 1300. No POS as per RT/LS/S/019. Rimini: DVD 245/02
SPC 1	ST PANCRAS - BEDFORD	6.0753	6.0753	Authorised Access Point - Pedestrian	Brent Park Road - U/B No. 44	Down Main/Fast	Single palisade gate and steps up the embankment to the Down Hendon cess.

Search Criteria: ELR(s) = SPC1; Mileage From = 5.0000; Mileage To = 7.0000							
Date: 28/06/2019							
SPC 1	ST PANCRAS - BEDFORD	6.0770	6.0770	Restricted Clearance	Limited Clearance at Under Bridge 44	Up Slow	ZIAR Ref No_266381_ Interim Reference No_HZ_3812 _Notes:
SPC 1	ST PANCRAS - BEDFORD	6.0770	6.0770	Buried Foul Water Service	Brent Park Road <Br. No. 44>		Public foul sewer in road under bridge No. 44.
SPC 1	ST PANCRAS - BEDFORD	6.0770	6.0770	Buried Water Main	Brent Park Road <Br. No. 44>		4" diameter water main in road under bridge No. 44.
SPC 1	ST PANCRAS - BEDFORD	6.0770	6.0770	Hazard Associated With Bridge	STRUCTURE SPC1-44 - BRENT PARK ROAD	All/Multiple Tracks	Structure SPC1-44 - Low Parapet/Handrail. Potential risk of falling
SPC 1	ST PANCRAS - BEDFORD	6.0770	6.0770	Restricted Clearance	Limited Clearance at Under Bridge 44	Down Main/Fast	ZIAR Ref No_266381_ Interim Reference No_HZ_3812 _Notes: